



THE BUSINESS

It all started in northern Romania with a brilliant idea that was constantly developed and improved over the years so that today it has become a successful business in the Eastern Europe automotive market: **ATP Exodus Group**.

We started in 1995 as a family business by importing and distributing spare parts for trucks. Today the company focuses its work in 3 major fields: truck spare parts, auto dealership, transport & freight forwarding.

ATP Exodus
GROUP



ATP Exodus Grup

ATP AUTOMOTIVE

ATP Automotive



ATP MOTORS

ATP Motors



Mercedes-Benz



mazda



 **SUZUKI**



ATP TRANSIT

ATP Transit



SPECIFIC COMPANIES

inmatic
solution

YIS
Your Image Solution

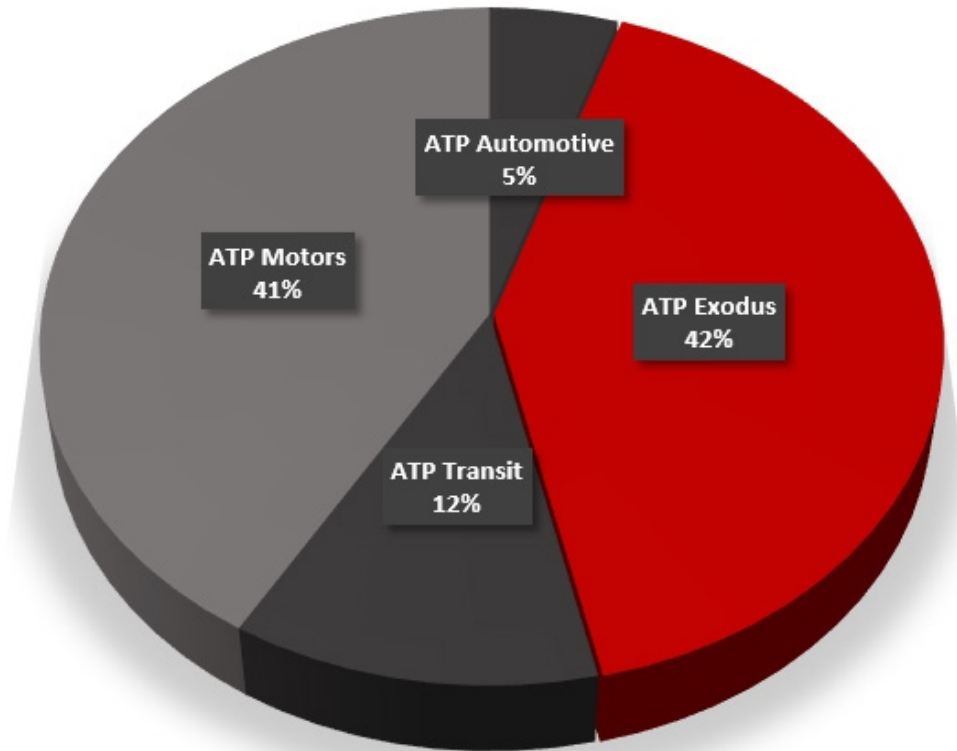

TURNOVER GROUP

Over € 82 mil (without other countries' turnover)

Total spare parts from total business (some are sold through ATP Motors) 61% - € 50 mil







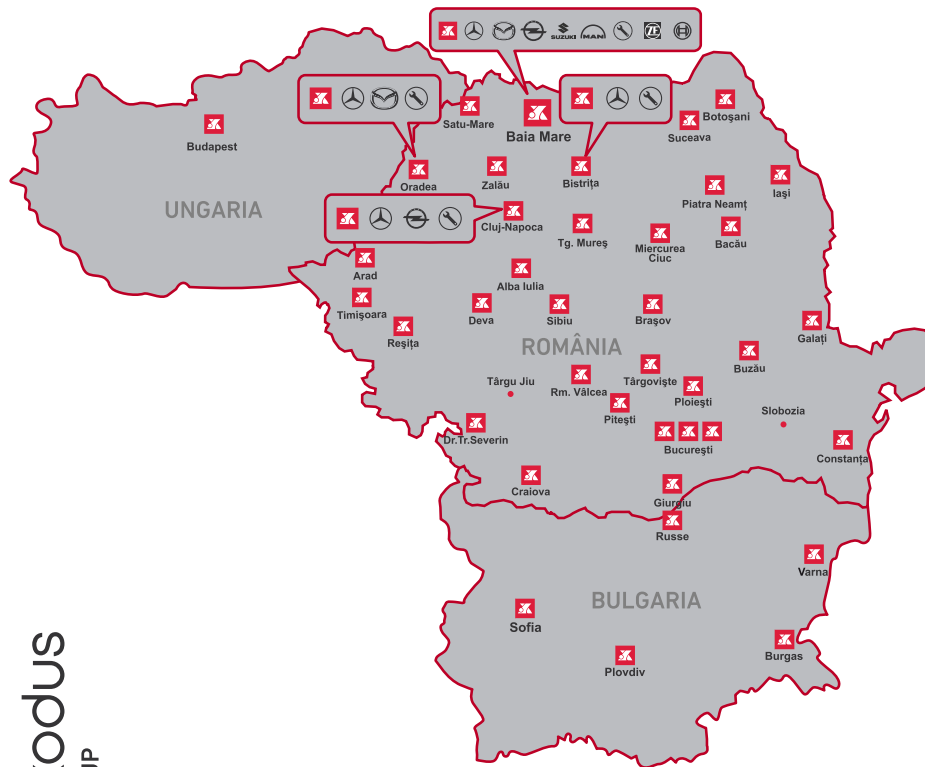



ATP EXODUS EMPLOYEES

Over 700 people





LEGEND

-  ATP Exodux Branches
-  Area Representatives ATP Exodux
-  ATP Exodux Truck Service
-  Mercedes-Benz Sales and Service
-  Mazda Sales and Service
-  Opel Sales and Service
-  Suzuki Sales and Service
-  MAN Sales and Service
-  ZF Service Partner
-  BOSCH Diesel Service Partner



OUR DIVISIONS

ATP Transit



ATP Automotive



ATP Motors



ATP Automotive

ATP Automotive is the largest division of **ATP Exodus Group**, which provides high quality parts for trucks by trading international brands and by manufacturing its own brand.



The ATP Automotive brand currently covers a broad range of product groups for European trucks, buses and trailers makers:

Daf, Iveco, Man, Mercedes, Renault, Scania, Volvo.

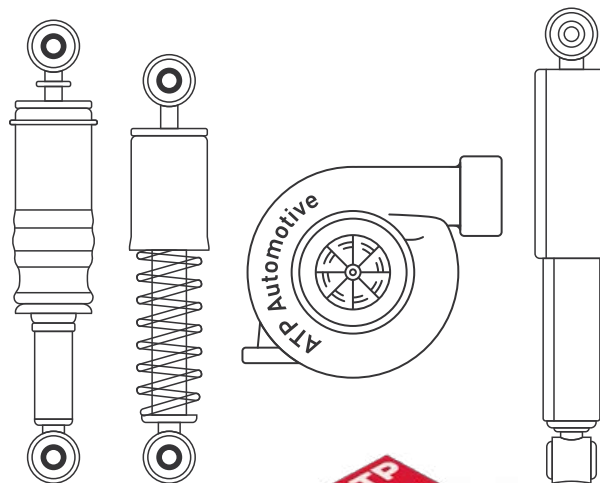

ATP Automotive

The ATP Automotive spare parts have the following advantages:

01

Quality at European standards, similar to OE

02

High stock availability, to ensure the shortest delivery time

03

Fast reaction to warranty claims and any other possible claims

04

High number of fast-moving codes for the applications and truck makers - the most usual ones





By launching its own branded products, ATP Automotive strengthens its positioning on the market of truck spare parts.

Our warehouse has a capacity of **8.000 pallets** and over **10.000 articles**.



ATP Automotive

ATP Automotive represents all brands of automotive, and we have solutions for all truck makers in Europe.



ATP Transit

**ALWAYS IN MOTION.
ON LAND, WATER, AIR.**

**The ATP Transit Division
provides domestic and
international courier services**

and operates on the general or dangerous goods cargo service market under full truckload or less than truckload shipping, with trucks from our private fleet or that of our partners'.



ATP Transit



ATP Motors

Brands such as MAN, Ford, Mercedes-Benz, Mazda, Opel and Suzuki are sold by the ATP Motors division, which also manages service for them, providing customers with the full range of motor vehicle services such as consultancy, maintenance, inspection and repair.



ATP Motors

SHOWROOMS & SERVICES

Mercedes-Benz Sales & Service

in Baia Mare, Bistrița, Oradea and Cluj, România

Mazda Sales & Service

in Baia Mare and Oradea, România

Opel

in Baia Mare and Cluj, România

Suzuki

in Baia Mare, România

MAN

in Baia Mare, România

Ford

in Baia Mare, România

Bosch & ZF Service

in Baia Mare, România





ATP Exodus GROUP

Sub Dura 4-5, Săsar RO-437229,
Maramureș

T: 0362 403 500

F: 0262 349 015

E: info@atp-exodus.com

atp-exodus.com

